

**OPERATING
INSTRUCTIONS
EN**

WHN712D1W



IO-WMS-3376
(08.2023/1)



ONLY USE THE APPLIANCE WHEN YOU HAVE
READ AND UNDERSTAND THE OPERATING
INSTRUCTIONS

WASHING MACHINES

UNPACKING

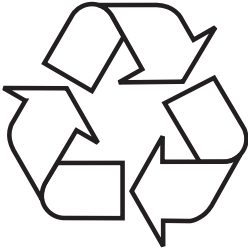

100% recyclable and are marked with the appropriate symbol.

Important! Packaging materials (bags, polyethylene, polystyrene, etc.) should be kept away from children during unpacking.

During transportation, protective packaging was used to protect the appliance against any damage. After unpacking, please dispose of all elements of packaging in a way that will not cause damage to the environment.

All materials used for packaging the appliance are environmentally friendly; they are

DISPOSAL OF OLD APPLIANCE



In accordance with European Directive 2012/19/EU and local legislation regarding used electrical and electronic goods, this appliance is marked with the symbol of the crossed-out waste container. This marking indicates that the appliance must not be disposed of together with other household waste after it has been used.

The user is obliged to hand it over to waste collection centre collecting used electrical and electronic goods. The collectors, including local collection points, shops and local authority departments provide recycling schemes.

Proper handling of used electrical and electronic goods helps avoid environmental and health hazards resulting from the presence of dangerous components and the inappropriate storage and processing of such goods.

CONTENTS

ECOLOGY IN PRACTICE	3
BASIC INFORMATION	5
SAFETY AND GERMENT CARE LABELS	6
INSTALL THE APPLIANCE	11
PRODUCT DESCRIPTION	15
TROUBLESHOOTING	20
PRACTICAL TIPS ON WASHING	24
WARRANTY AND AFTER SALES SERVICE	28

ECOLOGY IN PRACTICE

For many years, Hansa has consistently pursued pro-ecological policy. Concern for the environment is as important for us as the use of modern technology.

The development of technology has enabled our factories to become more environmentally friendly - we use less and less water, electricity and less waste water and solid waste is generated in the production.

A lot of attention is paid to materials used in production. We strive to use only those that do not contain harmful substances and make recycling and safe disposal possible after use.

Dear customer!

Thank you for choosing an Hansa product. For years we have delivered high-quality appliances, so that household chores become a real pleasure. Before being packaged and leaving the manufacturer, the appliance was thoroughly checked with regard to safety and functionality. We also endeavour to make sure that modern technology in Hansa products always goes hand in hand with a unique design.

Before using the appliance, please carefully read these Operating Instructions. Follow these instructions to avoid improper use and ensure long and reliable operation of the appliance. Learn the principles of the safe use to avoid accidents.

Store these operating instructions in a safe place to use them for reference whenever needed. These Operating Instructions contain all the necessary information that will make the use of your Hansa appliance simple and fun. We also encourage you to find out more about other Hansa appliances.

We hope using your new appliance is a pleasure.



BASIC INFORMATION



This washing machine is intended for domestic use only to wash textiles and clothes designed to be machine washed in a detergent bath.

Before plugging the washing machine into the mains, remove the safety packaging and ensure the machine is level. The manufacturer reserves the right to introduce changes, which do not affect operation of the appliance.

USAGE

- Carefully read the instructions below before using the appliance.
- Never use the appliance outdoors or anywhere the temperature may fall below freezing.
- The machine should not be operated by children or anyone who has not read the instructions.



Temperatures below 0°C can damage the washing machine! In the event of the machine being stored or transported in sub-zero temperatures, it should be left to acclimatise in a temperature above 0°C for 8 hours before being used.

Manufacturer's Declaration

The manufacturer hereby declares that this product meets the requirements of the following European directives:

- **Low Voltage Directive 2014/35/EU**
- **Electromagnetic Compatibility (EMC) Directive 2014/30/EU**
- **ErP Directive 2009/125/EC**
- **Directive RoHS 2011/65/EU**

and has thus been marked with the **CE** symbol and been issued with a declaration of compliance made available to market regulators.

The risk of death!	<p>This appliance should not be used by children under 8 years of age, persons with reduced physical or mental capabilities, and persons who do not have sufficient skills to use this type of appliance. Such persons should be offered proper supervision or instructions on safe handling of appliance and related risks. Children must not play with the appliance or perform any maintenance-related activities. Children under 3 years of age must be kept away from the appliance unless continuously supervised.</p>
	<p>Children could get caught inside the appliance and get into a life-threatening situation.</p>
	<p>Animals and children may climb into the machine. Check the machine before every operation.</p>
	<p>Kids should be supervised that they do not play with the appliance.</p>
	<p>Glass door may be very hot during the operation. Keep kids and pets far away from the machine during the operation very wet rooms as well as in the rooms with explosive or caustic gas.</p>
	<p>Remove all packages and transport bolts before using the appliance. Otherwise, serious damage may result.</p>

SAFETY AND GERMENT CARE LABELS

	Plug must be accessible after installation.
Risk of explosion!	Do not wash or dry articles that have been cleaned in, washed in, soaked in, or dabbed with combustible or explosive substances (such as wax, oil, paint, gasoline, degreasers, dry-cleaning solvents, kerosene, etc.) This may result in fire or explosion.
	Before hand thoroughly rinse items of washing by hand.
Installing the product!	This washing machine is for indoor use only.
	It isn't intended to be built-in using.
	The openings must not be obstructed by a carpet.
	Washing machine shall not be installed in bath room or very wet rooms as well as in the rooms with explosive or caustic gases.
	The washing machine with single inlet valve only can be connected to the cold water supply. The product with double inlet valves should be correctly connected to the hot water and cold water supply.

SAFETY AND GERMENT CARE LABELS



















Installing the product!	Plug must be accessible after installation.
	Remove all packages and transport bolts before using the appliance. Otherwise, serious damage may result.
Risk of damaging appliance!	Your product is only for home use and is only designed for the textiles suitable for machine washing.
	Do not climb up and sit on top cover of the machine.
	Do not lean against machine door.
	Cautions during Handling Machine: 1.Transport bolts shall be reinstalled to the machine by a specialized person. 2.The accumulated water shall be drained out of the machine. 3.Handle the machine carefully. Never hold each protruded part on the machine while lifting. Machine door can not be used as the handle during the conveyance. 4.This appliance is heavy. Transport with care.
	Please do not close the door with excessive forces. If it is found difficult to close the door, please check if the clothes are put in or distributed well.

SAFETY AND GERMENT CARE LABELS

Risk of damaging appliance!	It is forbidden to wash carpets.
Operating the appliance!	Before washing the clothes at first time, the product shall be operated in one round of the whole procedures without the clothes inside.
	Flammable and explosive or toxic solvents are forbidden. Gasoline and alcohol etc. Shall not be used as detergents. Please only select the detergents suitable for machine washing, especially for drum.
	Make sure that all pockets are emptied. Sharp and rigid items such as coin, brooch, nail, screw or stone etc. may cause serious damages to this machine.
	Please check whether the water inside the drum has been drained before opening its door. Please do not open the door if there is any water visible.
	Be careful of burning when the product drains hot washing water.
	Never refill the water by hand during washing.
	After the program is completed, Please wait for two minutes to open the door.

SAFETY AND GERMENT CARE LABELS

UNDERSTANDING THE SYMBOLS ON CLOTHES LABELS

Washing				
	boil at 90°C	normal wash at 60°C	normal wash at 40°C	Do NOT wash!
				
	delicate		handwash	
Chemical cleaning				
	all solvents	all except TRI	petrol only	NO Dry clean!
Tumble dryer				
	normal	low	high	Do NOT dry!
Ironing				
	110°C	150°C	200°C	Do NOT Iron



Always pay attention to the symbols on garment labels when choosing a washing programme.

INSTALL THE APPLIANCE

1

Remove the transit bolts

(keep the bolts for future use, e.g. when moving house).

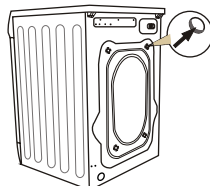
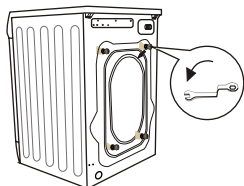

- unscrew the 4 transit bolts with a spanner,
- stop up the holes with the stoppers enclosed in the accessories bag.
- remove the rubber and plastic transport brackets from the sockets along with the washers and bolts.



Caution: the transit bolts **MUST** be removed before the washing machine is used!

2

Position and level the washing machine

- place the washing machine on a solid, level surface,
- loosen the plastic washer (2)
- Level the appliance by adjusting the legs (1)
- lock with washers (2)

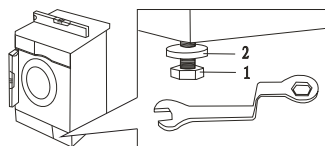
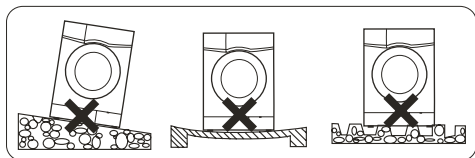

After positioning and levelling the appliance, check that it is stable by pressing down each corner and ensuring it does not move!



Attention!

The protection panels are used to additionally mute the appliance. The panels should be installed before removing the transport locks. Installation should be carried out by at least two people. Place the appliance on the back wall. Place a soft material, e.g. a sponge or cloth, to protect the appliance. Peel off the adhesive tape and stick it on the bottom hole under the washing machine. And now you can enjoy silent washing.

**Attention!**

The protective plates are used for additional soundproofing of the appliance. The plates must be attached before removing the transit bolts. At least two people are required for assembly. Lay the appliance on the back wall. Place a soft material, e.g. sponge or cloth, underneath to protect the appliance. Peel off the protective tape and stick the soundproofing on the lower opening under the washing machine. And you can enjoy the quiet washing.

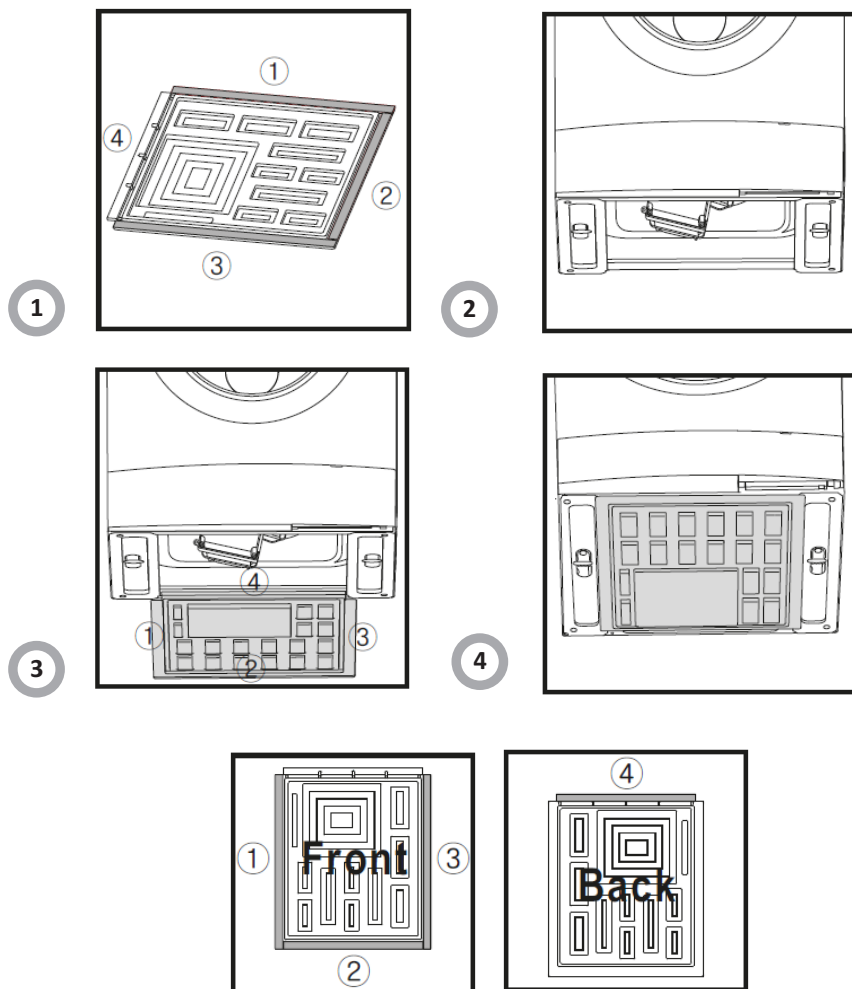

4

Connect the water supply

- Use only the new hoses supplied with the machine. Do not re-use hoses.

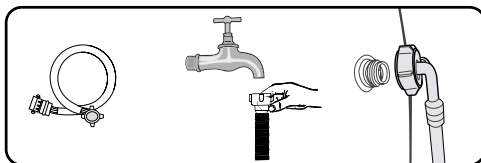

- A supply hose with seals is inside the drum of the machine.
Water pressure min 0.05 MPa (0.5 bar), max 1 MPa (10 bar).

- 1). after connecting, make sure the hose is not twisted
- 2). after connecting the hose and the valve, check they are sealed tight
- 3). regularly check the condition of the hose.



Supply the machine with cold water only.

5

Water drain

- The drain hose is at the back of the machine. Fix the drain hose so that it does not move while the washing machine is in operation. If necessary, use the elbow (1).

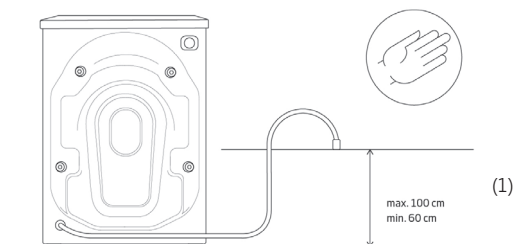

Connection on the left

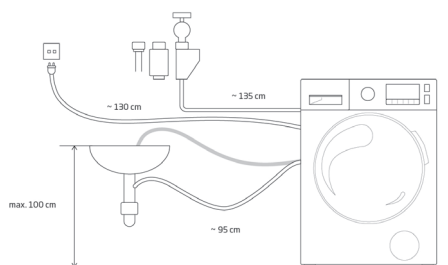

Connection on the right

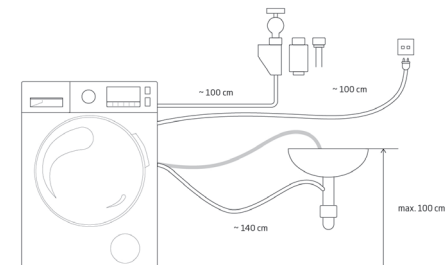

Connect to power supply

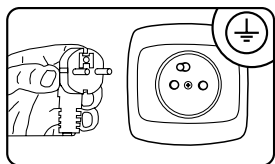

- Electrical wall outlet where the appliance is connects must be in a visible and accessible place,
- Only plug the appliance into a properly installed socket with an earthing pin,
- Do not use an extension cord to connect the appliance,
- in the event of the power cord being damaged, it must be replaced by an authorised service technician,
- the electrical system to which the appliance is to be connected must be protected with a 10 A fuse.

Prepare to wash:



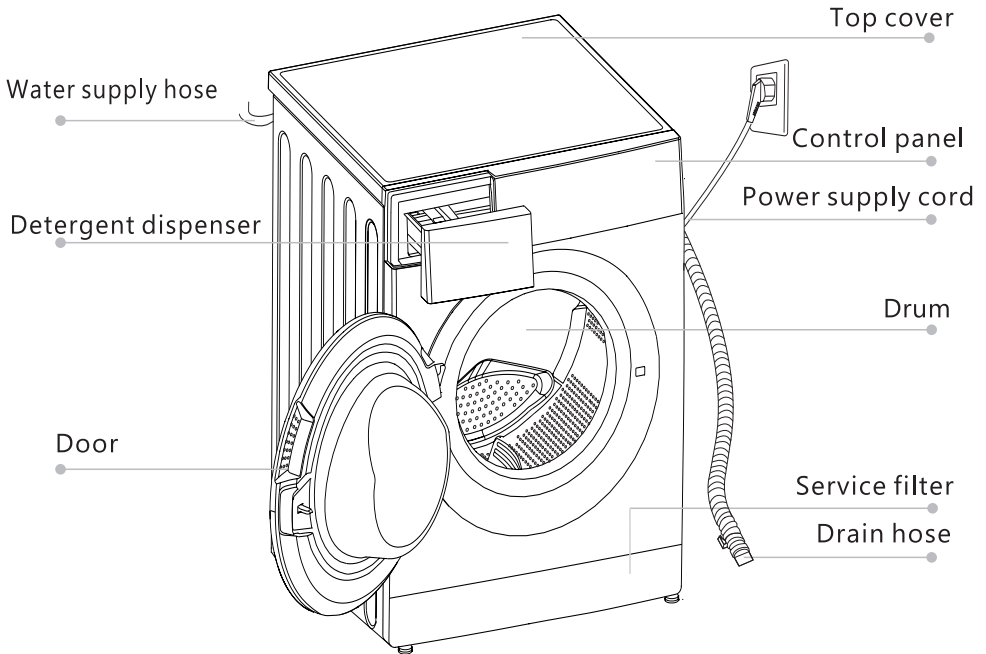

- Small items such as coins, paper clips, needles, etc., may damage the laundry and the washing machine, you should therefore follow a few important recommendations:
 - 1). Empty pockets
 - 2). Remove all metal items
 - 3.) Delicate items such as bras or stockings should be washed in protective mesh laundry bag
 - 4). Close zippers and fasten buttons
 - 5). Remove any foreign objects from the appliance.

FEATURES AND COMPONENTS

DESCRIPTION OF THE APPLIANCE



■ Accessories:

				
Transport hole plug	Plug for the opening (optional)	Supply hose cold water	Supply hose warm water (optional)	Drain hose support (optional)

DISPLAY AND CONTROL PANEL

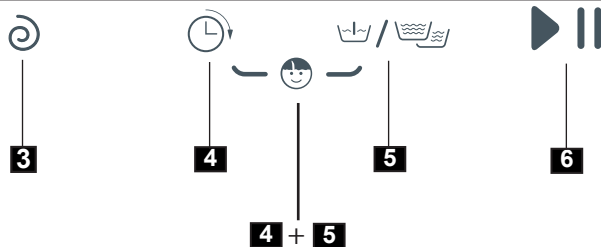
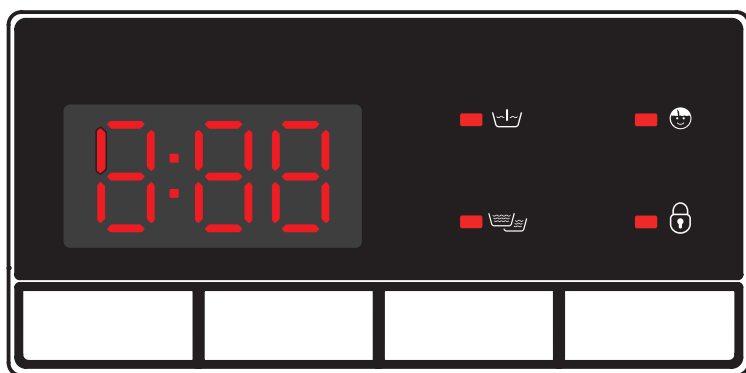
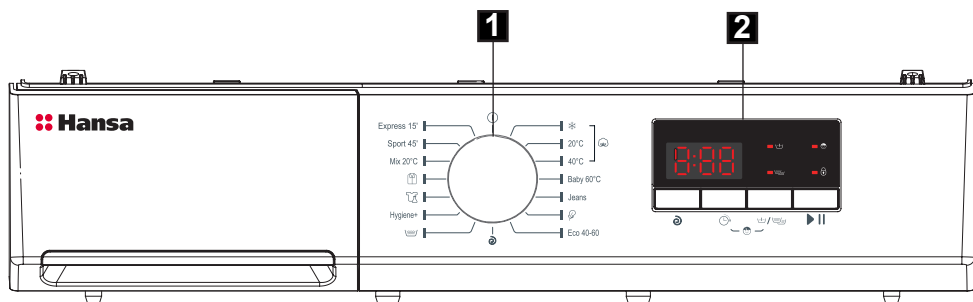



1. Programme button
2. Display
3. Spin speed button
4. Delay Start button
5. Function button (Prewash / Extra Rinse)
6. Start/Pause

4+5. Child Lock

1. Programme selector dial

Choose the appropriate wash programme as required, depending on the soil level, and type and amount of laundry loaded, which ensures better results and more effective washing. Once the wash programme is started, turning the programme selector knob to another position is indicated by a beep, however it does not change the previously selected programme.

2. Display

When the washing machine operates, the display shows the time left to the end of the wash programme. The display shows the following symbols: Lock the washing machine door  and activate the Child Lock 

Time indication is approximate and will vary depending on temperature, water pressure, load, amount of detergent etc. The time indication is automatically updated during the wash cycle and it may pause or change abruptly.

When the delay start function is selected, the display shows the time until the start of the wash programme.

When you set the spin speed, the following values are displayed in sequence:

0 (spin off) - 400 - 600 - 800 - 1000 - 1200.

3. Spin speed selector button

Press this button to set the spin speed when water is being pumped out of the washing machine.

Press the button to change the setting. Depending on the programme selected, the display shows the following values: 0 (spin off) - 400 - 600 - 800 - 1000 - 1200.

4. Delay Start button

Press this button to delay the start of the wash programme. The setting range available is from 0-24 hours. Press the button to set the time after which washing is to commence.

NOTE: If there is a power outage during Delay Time, countdown will resume immediately after the power is restored.

5. Function selection button

Use the multi-function button to select one of the two functions (extra rinse or prewash) or both. When this function is activated, the LED above the symbol of the selected function lights up.

Notes: The Extra Rinse and Prewash functions are not available in all programmes (see table of wash programmes).

Pre-wash

The prewash function extends the washing time by about 20 minutes. Before the main wash, there is an additional wash cycle at 30°C.

Thanks to the prewash function, you can achieve good washing results without pre-soaking. This function is recommended for heavily soiled laundry.

Note: Before starting the prewash function, pour detergent into the drawer with the  symbol.

Extra Rinse

The extra rinse is especially recommended for washing underwear and clothes of people with sensitive skin. This function adds an extra rinse to the wash programme.

6. START/PAUSE button

Press **Start/Pause** to start or pause a programme.

During the washing cycle the corresponding programme phase symbol is flashing. In **Pause** mode, the symbols do not flash and are lit up continuously. The Pause mode can be used to soak the laundry.

Once the selected programme has started wait for about 10 minutes and then press the **Start/Pause** button. When the laundry is soaked as required, press the **Start/Pause** button again to resume the programme. Soaking will improve washing results for heavily soiled laundry.

4 + 5 Child Lock

The Child Lock disables buttons to prevent children from inadvertently changing settings. To activate the Child Lock during a wash programme, simultaneously press for 3 seconds the **4** (programme start time) and the **5** (function) buttons. To deactivate this Child Lock during the wash cycle, press the same buttons again for 3 seconds.

Note 1: If the Child Lock is active, the  symbol is shown on the display.

Note 2: Child Lock will not be automatically released after the wash cycle is completed.

SPECIAL PROGRAMMES

1

Express 15'

■ A very short program to wash a small amount of lightly soiled clothes. Use this programme to refresh clothes. Includes all three wash stages:

1). Main wash 2). Rinse 3). Spin.

2

ECO 40-60

■ The "Eco 40-60" programme is used to wash normally soiled cotton fabrics, which can be washed at 40°C or 60°C in the same cycle.

3

20°C

■ Provide better protection for when washing coloured laundry.

USING THE APPLIANCE

I. Select Programme

1. Set the programme selector knob to the desired programme (see the table further on).
2. Change temperature, spin speed or activate available additional functions to modify the programme to your individual needs.
3. Press the Start/ Pause button.

II. Set Delay Start

The delayed start function may be used when, for example, taking advantage of discounted electricity tariffs.

Procedure:

1. Close the door.
2. Set the programme selector knob to the desired programme (see the table further on).
3. Select additional functions or wash cycle parameters as required.
4. Press the Delay Start button.
5. Select time ranging from 3h/6h/9h/12h hours. The display will show the setting from 3h/6h/9h/12h.
6. Press the [Start/ Pause] button. The appliance will be set in delay mode. Washing will commence immediately after the delay time has elapsed.

Note: If you set delay start, the display will show the time remaining to start the washing program.

III. End of the wash cycle

1. End of the wash cycle is indicated by acoustic signal (if active). The display shows 0:00 and the door lock indicator light goes out.
2. Close the water valve.
3. Switch the machine off.
4. Unplug the appliance from the wall outlet.
5. Open the door and remove laundry.

IV. Cancel or modify programme

Press the On/Off button to interrupt the programme. Then select the desired wash program again and press the Start/Pause button.

TROUBLESHOOTING

Problem	Probable cause/Solution
The washing machine is not working	<p>Open the water supply tap.</p> <ul style="list-style-type: none"> - clean the mesh filter on the supply hose - close the door - press the Start/ Pause button
Water Leakage	<ul style="list-style-type: none"> - Properly connect the water supply hose.
The load in the appliance has not been spun	<ul style="list-style-type: none"> - Replace the load evenly in the drum, clean the pump filter.
Unpleasant smell in the drum	<ul style="list-style-type: none"> - Run the drum autoclean programme
No water in the drum	<ul style="list-style-type: none"> - Open the water supply tap.
There is water left in the fabric softener container.	<ul style="list-style-type: none"> - Press down on the plastic tab located in the central compartment of the detergent tank.
Washing not properly rinsed	<ul style="list-style-type: none"> - Add correct amount of detergent, depending on the soiling level and water hardness (see the instructions on the detergent packaging).
The appliance does not fill with water	<ul style="list-style-type: none"> - Open the water valve, - check programme settings, - check water pressure, - reconnect the water supply hose. - close the door - check that water intake hose is not bent or blocked
Simultaneous water intake and draining.	<p>Check that the end of the drain hose is higher than the level of the water in the appliance (the hose should be at a height of 0-100 cm).</p>
Water does not drain properly	<ul style="list-style-type: none"> - check the pump filter, - check the drain hose, - check the placement of the drain hose – it should be at a height of 0.5 to 1 m from the floor.

Problem	Probable cause/Solution
Appliance vibrating	<ul style="list-style-type: none"> - Check if transit bolts are removed - level the washing machine, - lock the washing machine feet by tightening the nuts.
Foam leaks from the detergent drawer.	<ul style="list-style-type: none"> - Reduce the amount of detergent used - Check the water hardness and the amount of detergent used, - Use detergent according to manufacturer instruction on the box indicated for your water hardness.
The operation of the appliance is interrupted before the programme has finished	<ul style="list-style-type: none"> - Check electric power supply, water supply and water outlet.
Noise caused by operation of the outlet pump after water is removed	<ul style="list-style-type: none"> - There is no reason for concern. The water has been removed from the drum, but small amounts remain in the pump and outlet lead. Constant operation of the outlet pump causes air to be sucked in leading to the characteristic noise, which does not mean that anything is wrong.
Short breaks during the wash cycle	<ul style="list-style-type: none"> - Water in the appliance is being automatically refilled - Pause caused by removal of excess foam

THE FAULT INDICATOR LIGHTS

The washing machine has an alarm system, which helps solving minor problems connected with incorrect operation by means of "ERROR CODES" indicated in the display. With the ERROR CODES you can locate the defect and establish the cause.

If an error is found, the display shows information in accordance with the following table:

Display indication	Reason	Explanation
E10	Low water pressure, no water in the washing machine.	Open the water valve, check the water inlet hose and filter, check water pressure
E12	Overflow	Re-commissioning the appliance.
E21	Water does not drain properly	Check water drain pump and filter.
E30	The door is not closed.	Check, if the door of the washing machine is closed. Check, if no clothing is stuck in the door of the washing machine.
Others		Try to restart or contact the SERVICE CENTRE.



While signaling an error washing machine also beeps (if active).

1

Clean the drain pump filter

- Clean the pump filter every 20 washes or so. Neglecting to clean the filter may result in problems with draining water from the appliance!

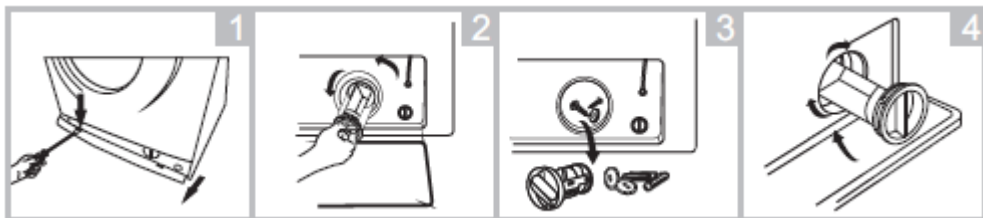

- 1). open the service filter,
- 2). open the filter by turning to the counter clockwise,
- 3). remove and clean the filter,
- 4). close the lower cover cap.

2

Clean the water supply valve

- Replace the filter following the procedure in reverse order.

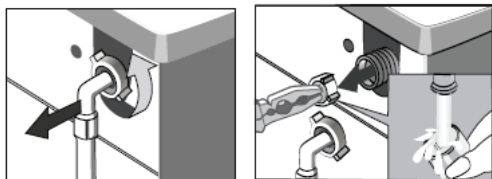

- 1). unscrew on the water supply hose,
- 2). use forceps to grasp the filter mesh pin,
- 3). remove and clean the filter, preferably using a brush.

3

Clean the detergent drawer

- Should be cleaned at least once a month.

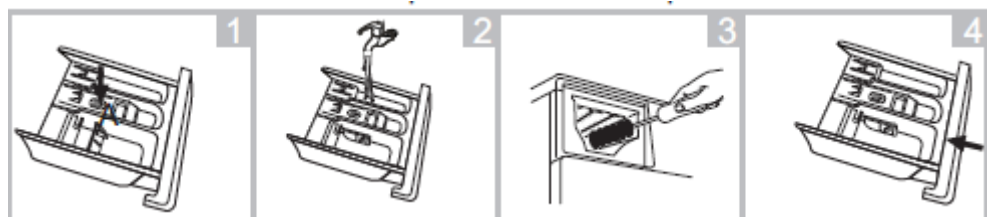

- 1). pull out the detergent drawer.
Press down the tab and completely remove the drawer.
- 2). rinse under running water, clean with a brush or a piece of fabric,
- 3). clean inside the recess with an old toothbrush,
- 4). replace the drawer.

PRACTICAL TIPS ON WASHING

DETERGENTS AND LAUNDRY ADDITIVES



It is recommended to use a general-purpose laundry detergent powder or liquid for the full range of temperatures according to the manufacturer's instructions on the detergent packaging.

1

Detergents

- Pour the detergent into the drawer compartment marked
- Pour the pre-wash detergent into the drawer compartment marked

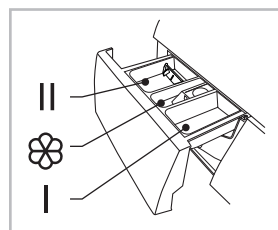

2

Fabric softeners added to the rinse

- Pour the fabric softener into the drawer compartment marked
- Do not exceed the maximum level marked on the drawer compartment. This detergent will be used for the final rinse.



For washing whites it is recommended to use the washing powder. Liquid detergents do not contain bleach. Do not use rinse aid with white laundry, as this may cause yellowing of laundry.

FIRST WASH

- Before washing for the first time, put the appliance through one high temperature cycle without a load, according to the following procedure:
 - 1). connect the washing machine to the power supply,
 - 2). open the water valve,
 - 3). set the programme selector dial to washing at high temperature, add a suitable detergent and press Start/Pause.

SOIL

1

Stubborn stains

- Before washing underwear, apply an additional stain remover according to the instructions for use.

2

Heavy soil

- in order to achieve a better result, wash less laundry,
- add more detergent.
- Rinse the washing machine after washing heavily soiled garments (e.g. work clothes) or clothing that loses fibres. To do this, run the wash cycle at 60°C, for example Cotton or Synthetics without any load.

3

Light soil

- See Conservation.

CONSERVATION

Reduce energy and water consumption

- Garments which are only lightly soiled should be washed on the Rapid Wash setting.
- For most programmes, the washing machine detects load. For partial load, when using the QUICK WASH programme, the appliance will reduce water and energy consumption and shorten the wash cycle.
- The most energy and water efficient wash programmes are generally those that run at lower temperature and for a long time.
- Loading the washing machine to the full capacity indicated by the manufacturer for the respective wash programmes will save energy and water.

WATER HARDNESS

- Hard water causes scale deposition. Information about water hardness is available from the nearest water works. We recommend that you use water softener for each washing.

POWER OUTAGE (PROGRAMME MEMORY)

- Power outage or unplugging the appliance does not cancel the set programme. The programme is memorised and resumes when power is restored. Do not open the appliance doors during a power outage.

LOAD

- Maximum drum capacity 7 kg.
- Load the laundry into the drum according to the following instructions:

- 1). cotton, denim, children's clothes - max full drum (do not force clothes into the drum as this will reduce the quality of the wash),
- 2). Synthetics - max $\frac{1}{2}$ of the drum,
- 3). Delicates fabrics - $\frac{1}{3}$ of the drum.



Do not overload the appliance. Overloading the appliance may damage the clothes being washed! If you overload the appliance the OVL is shown appears on the display – remove excess laundry from the drum and restart the washing machine. The maximum load amounts depending on the programme are given in table of programmes.

LOAD DISTRIBUTION CONTROL

- The appliance features load distribution control system. Before spinning, this checks the distribution of clothes inside the drum. In the event that too great an imbalance is detected, the system makes several attempts to rearrange the clothes inside the appliance. Sometimes these attempts to distribute the load are not successful. Problems may be caused by terrycloth robes washed together with other types of laundry, such as bed sheets that formed a bundle around other items of laundry.
- The system may then respond in two ways:
 - 1). accept the uneven distribution of garments and reduce spin speed,
 - 2). cancel the spinning.

In either case, after washing cycle is finished open the appliance door, remove the laundry by hand, close the door and select the spin setting again.

DOOR LOCK

- The washing machine is equipped with a lock which prevents the door from being opened during wash cycle. Once a wash cycle is complete, the door lock is automatically released. In order to open the door during the wash program, press PAUSE button and wait to unlock the door.



If the temperature inside the drum is high, the door may remain blocked until the water temperature has dropped below 60°C.



Before opening the door of the washing machine check whether there is water in the drum.

DELICATE FABRICS

1

Select Programme

- Select the appropriate wash programme: Synthetics, Wool.

2

Load

- Avoid overloading the washing machine – the maximum load is 1/3 kg for delicate fabrics, see "Loading."

ADD DETERGENT

1

Not enough detergent

- the laundry turns grey, lumps of fat form, lime scale is deposited.

2

Too much detergent

- A lot of foam, ineffective washing, detergent incompletely rinsed from fabrics.

For more information about the product, please refer to the EU EPREL Product Database at <https://eprel.ec.europa.eu>. For more information, please use your mobile device to scan the QR code on the energy label or enter the product model listed on the energy label in the EPREL search engine <https://eprel.ec.europa.eu/>

WARRANTY AND AFTER SALES SERVICE

Warranty

Warranty service as stated on the warranty card. The manufacturer shall not be held liable for any damage caused by improper use of the product.

Service

- The manufacturer recommends that all repairs and adjustments be carried out by the Factory Service Technician or the Manufacturer's Authorized Service Point. For safety reasons, repairs should be referred to professionals.
- Repairs carried out by unqualified persons may seriously endanger the appliance user.
- Pursuant to Commission Regulation (EU) 2019/2023, the minimum availability period for spare parts necessary to repair the appliance is 7 or 10 years depending on the type and purpose of the spare part.
- The list of spare parts and the ordering procedure are available on the websites of the manufacturer, importer or an authorized representative.
- The minimum warranty period for the appliance offered by the manufacturer, importer or authorized representative is given in the warranty card.
- The warranty shall be void if you make any independent adaptations or alterations, tamper with seals or other appliance safety devices or its parts or interfere with the appliance contrary to operating instructions.

In the event of appliance malfunction, request assistance or repair.

If your appliance needs repair, please contact the service centre. Please see warranty card for address and contact details of our service centre. Before contacting us, please have ready the appliance serial number, which can be found on the identification sticker: For your convenience, please write it down below:

--	--	--	--	--	--	--	--	--	--	--	--	--	--	--	--	--	--	--	--	--	--	--



ERC



**UK
CA**

CE